

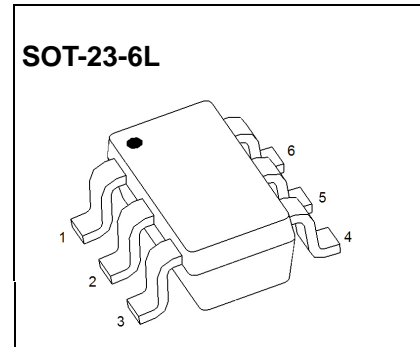

SOT-23-6L Plastic-Encapsulate MOSFETS

CJL2623 Dual P-Channel MOSFET

$V_{(BR)DSS}$	$R_{DS(on)MAX}$	I_D
-30V	130mΩ@-10V	-3A
	180mΩ@-4.5V	



FEATURE

- TrenchFET Power MOSFET
- Low Gate Charge
- Low On-resistance
- Surface Mount Package

APPLICATION

- DC/DC converter
- Load switch for portable devices
- Commercial-industrial applications

MARKING:

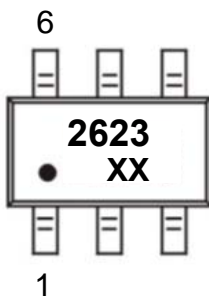

2623=Device code
Solid point=Pin1 positioning point
XX=Date Code

Equivalent Circuit

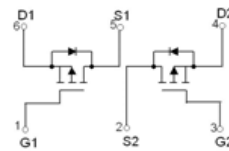

ABSOLUTE MAXIMUM RATINGS (T_a=25°C unless otherwise noted)

Parameter	Symbol	Value	Unit
Drain-Source Voltage	V _{DS}	-30	V
Gate-Source Voltage	V _{GS}	±20	V
Continuous Drain Current	I _D	-3	A
Pulsed Drain Current (note 1)	I _{DM}	-20	A
Power Dissipation (note 2)	P _D	0.35	W
Thermal Resistance from Junction to Ambient	R _{θJA}	357	°C/W
Operation Junction and Storage Temperature Range	T _J , T _{STG}	-55~ 150	°C

- Notes :**
1. Pulse width limited by Max.junction temperature.
 - 2.Per element must not be exceeded

MOSFET ELECTRICAL CHARACTERISTICS

$T_a=25^\circ\text{C}$ unless otherwise specified

Parameter	Symbol	Test Condition	Min	Typ	Max	Unit
STATIC PARAMETERS						
Drain-source breakdown voltage	$V_{(BR)DSS}$	$V_{GS} = 0V, I_D = -250\mu A$	-30			V
Zero gate voltage drain current	I_{DSS}	$V_{DS} = -30V, V_{GS} = 0V$			-1	μA
Gate-body leakage current	I_{GSS}	$V_{GS} = \pm 20V, V_{DS} = 0V$			± 100	nA
Gate threshold voltage	$V_{GS(th)}$	$V_{DS} = V_{GS}, I_D = -250\mu A$	-1		-3	V
Drain-source on-resistance (note 3)	$R_{DS(on)}$	$V_{GS} = -10V, I_D = -3A$		75	130	$m\Omega$
		$V_{GS} = -4.5V, I_D = -2A$		115	180	$m\Omega$
Forward tranconductance	g_{FS}	$V_{DS} = -5V, I_D = -2A$		2		S
Diode forward voltage (note 3)	V_{SD}	$I_S = -1A, V_{GS} = 0V$			-1.2	V
DYNAMIC PARAMETERS (note 4)						
Input Capacitance	C_{iss}	$V_{DS} = -25V, V_{GS} = 0V, f = 1MHz$			240	pF
Output Capacitance	C_{oss}			42		pF
Reverse Transfer Capacitance	C_{rss}			32		pF
SWITCHING PARAMETERS (note 3,4)						
Turn-on delay time	$t_{d(on)}$	$V_{DD} = -15V, V_{GS} = -10V, I_D = -1A$ $R_D = 15\Omega, R_G = 3.3\Omega$		5		ns
Turn-on rise time	t_r			6		ns
Turn-off delay time	$t_{d(off)}$			15		ns
Turn-off fall time	t_f			3		ns
Total Gate Charge	Q_g	$V_{DS} = -24V, V_{GS} = -4.5V, I_D = -2A$			4.5	nC
Gate-Source Charge	Q_{gs}			0.5		nC
Gate-Drain Charge	Q_{gd}			1.4		nC

Notes : 3. Pulse Test : Pulse width $\leq 300\mu s$, duty cycles $\leq 2\%$.

4. Granted by design, not subject to production testing.

Typical Characteristics

Output Characteristics

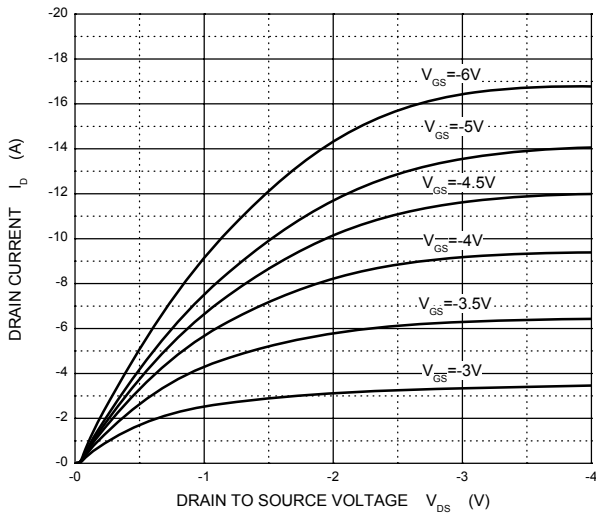

Transfer Characteristics

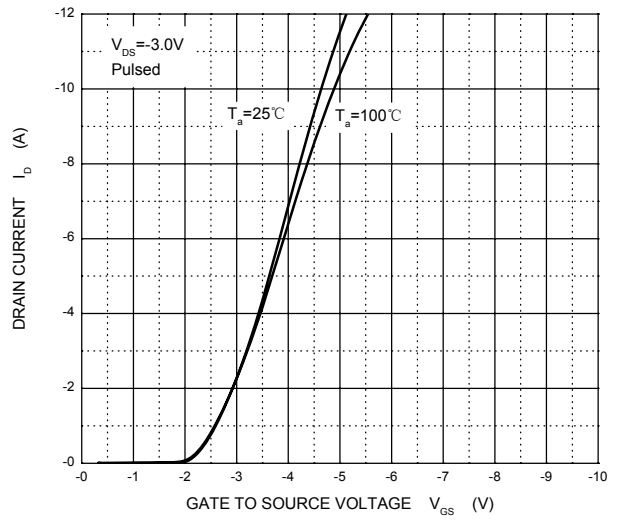

$R_{DS(ON)}$ — I_D

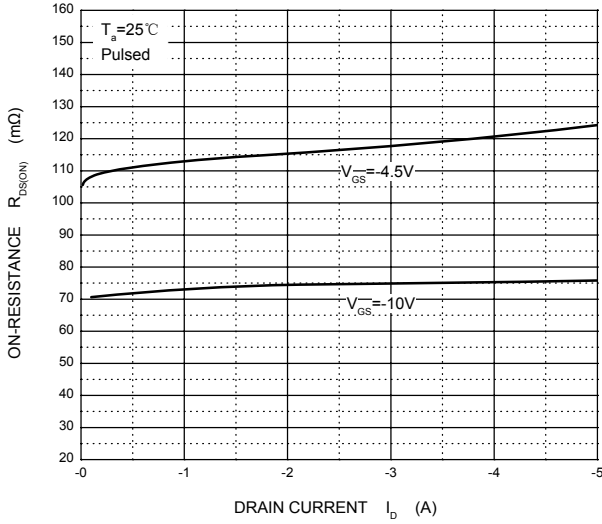

$R_{DS(ON)}$ — V_{GS}

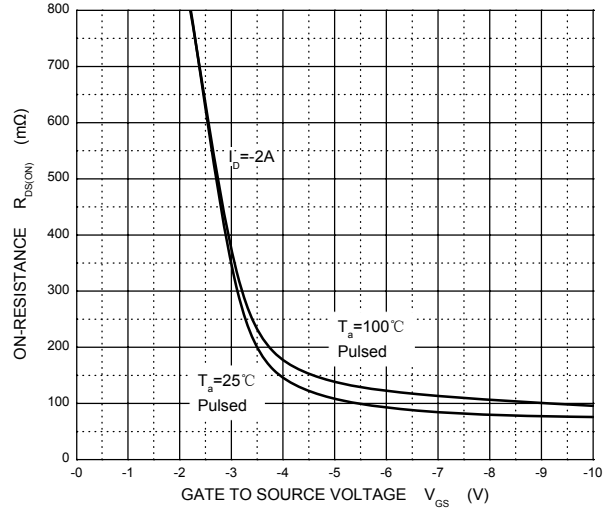

I_S — V_{SD}

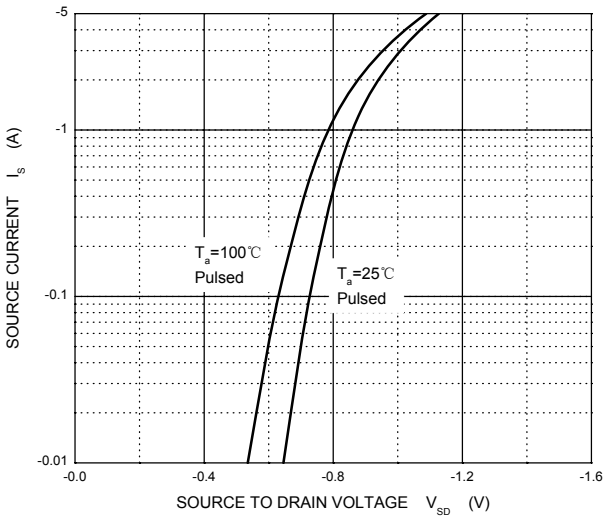

Threshold Voltage

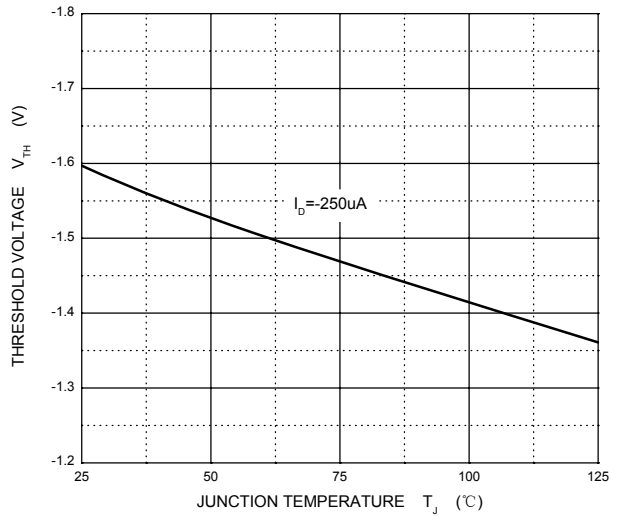

SOT-23-6L Package Outline Dimensions

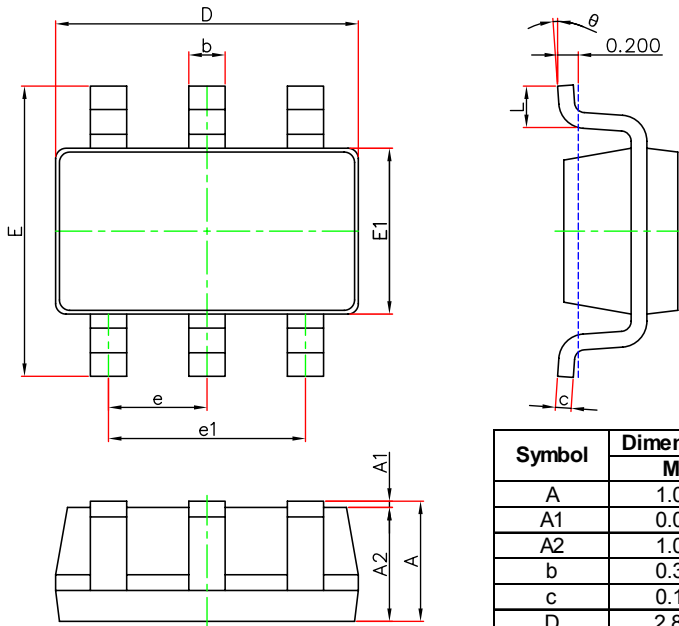

Symbol	Dimensions In Millimeters		Dimensions In Inches	
	Min.	Max.	Min.	Max.
A	1.050	1.250	0.041	0.049
A1	0.000	0.100	0.000	0.004
A2	1.050	1.150	0.041	0.045
b	0.300	0.500	0.012	0.020
c	0.100	0.200	0.004	0.008
D	2.820	3.020	0.111	0.119
E1	1.500	1.700	0.059	0.067
E	2.650	2.950	0.104	0.116
e	0.950(BSC)		0.037(BSC)	
e1	1.800	2.000	0.071	0.079
L	0.300	0.600	0.012	0.024
θ	0°	8°	0°	8°

SOT-23-6L Suggested Pad Layout

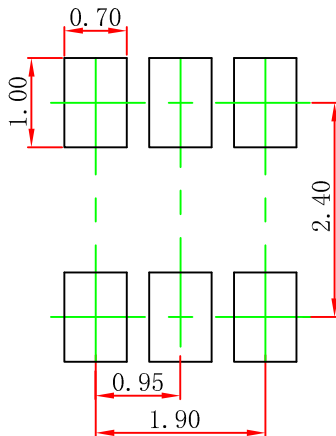

- Note:
1. Controlling dimension: in millimeters.
 2. General tolerance: ± 0.05 mm.
 3. The pad layout is for reference purposes only.

NOTICE

JSCJ reserves the right to make modifications, enhancements, improvements, corrections or other changes without further notice to any product herein. JSCJ does not assume any liability arising out of the application or use of any product described herein.

SOT-23-6L Tape and Reel

SOT-23-6L Embossed Carrier Tape

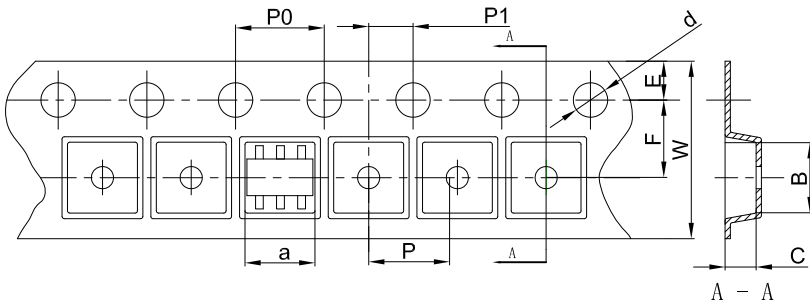

Packaging Description:

SOT-23-6L parts are shipped in tape. The carrier tape is made from a dissipative (carbon filled) polycarbonate resin. The cover tape is a multilayer film (Heat Activated Adhesive in nature) primarily composed of polyester film, adhesive layer, sealant, and anti-static sprayed agent. These reeled parts in standard option are shipped with 3,000 units per 7" or 18.0cm diameter reel. The reels are clear in color and is made of polystyrene plastic (anti-static coated).

Dimensions are in millimeter										
Pkg type	a	B	C	d	E	F	P0	P	P1	W
SOT-23-6L	3.17	3.23	1.37	Ø1.55	1.75	3.50	4.00	4.00	2.00	8.00

SOT-23-6L Tape Leader and Trailer

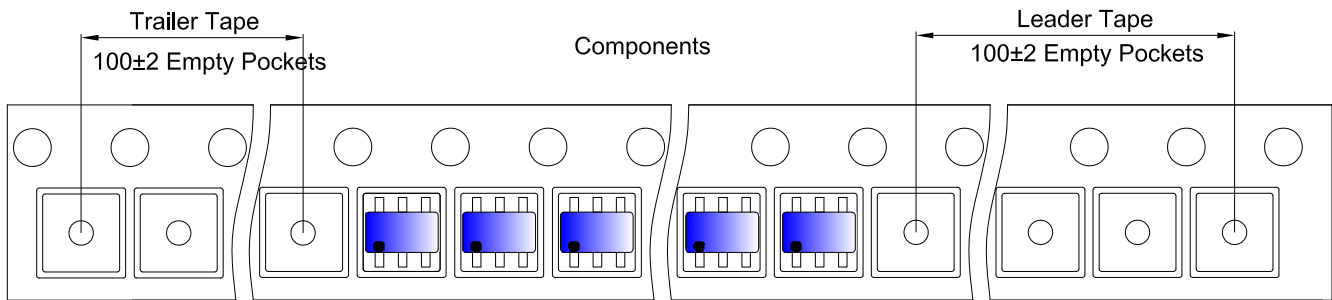

SOT-23-6L Reel

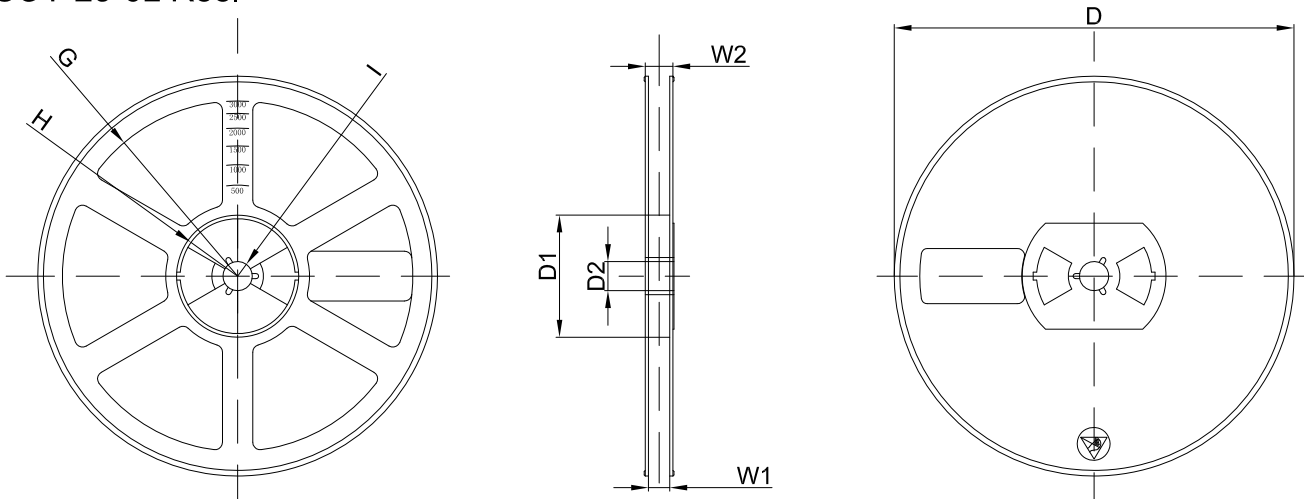

Dimensions are in millimeter								
Reel Option	D	D1	D2	G	H	I	W1	W2
7"Dia	Ø180.00	60.00	13.00	R78.00	R25.60	R6.50	9.50	13.10

REEL	Reel Size	Box	Box Size(mm)	Carton	Carton Size(mm)	G.W.(kg)
3000 pcs	7 inch	30,000 pcs	203×203×195	120,000 pcs	438×438×220	